

Types of Angles Questions Part 9

Determine each of the following unknown angles, giving reasons for your answers

A)

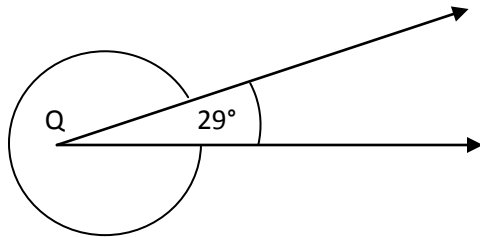

B)

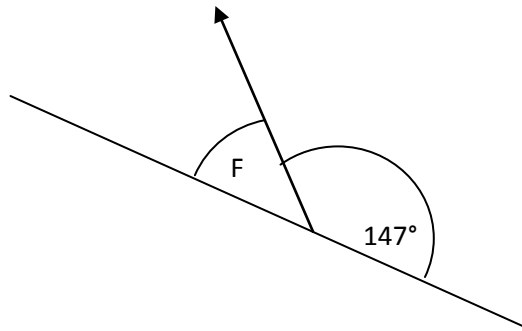

C)

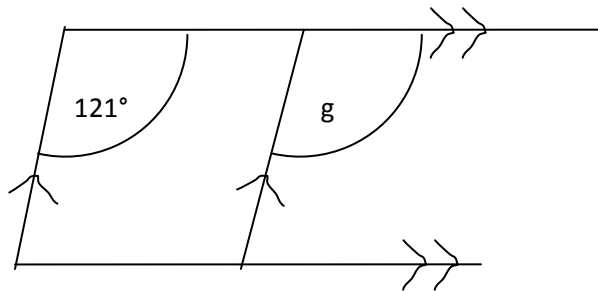

D)

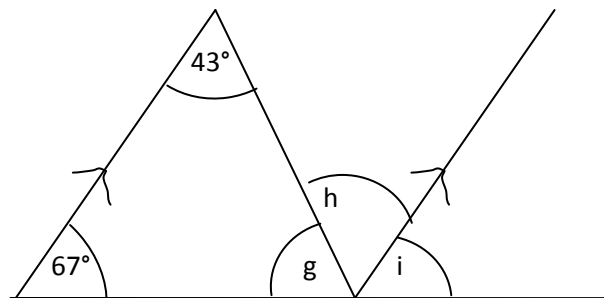

E)

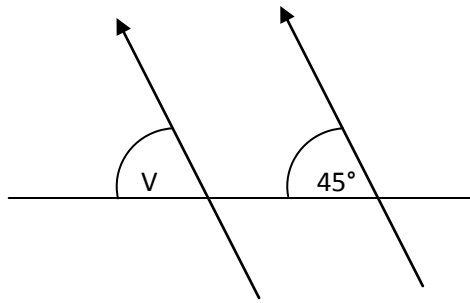

F)

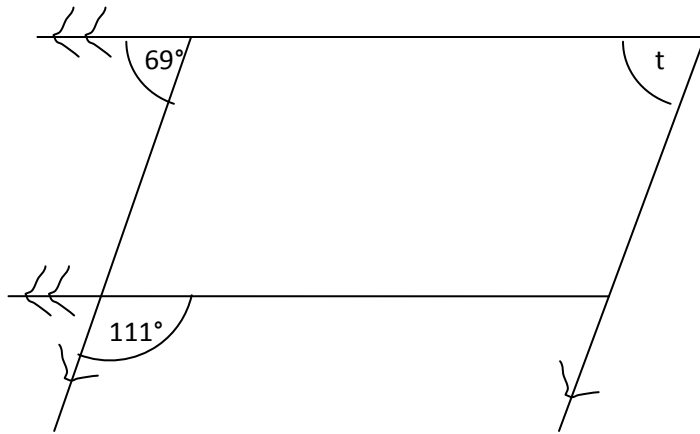

G)

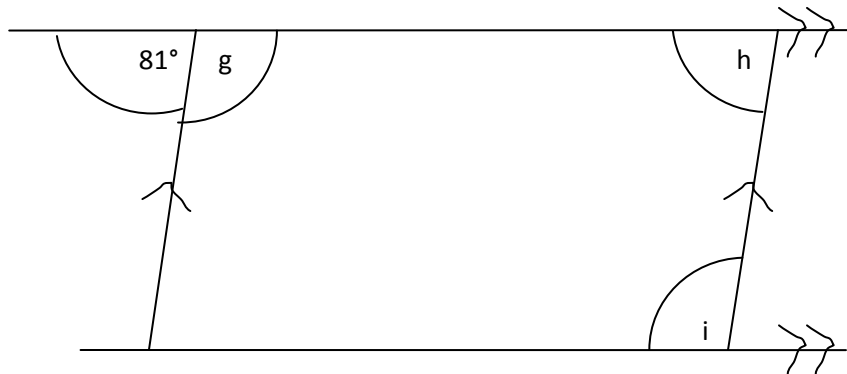

H)

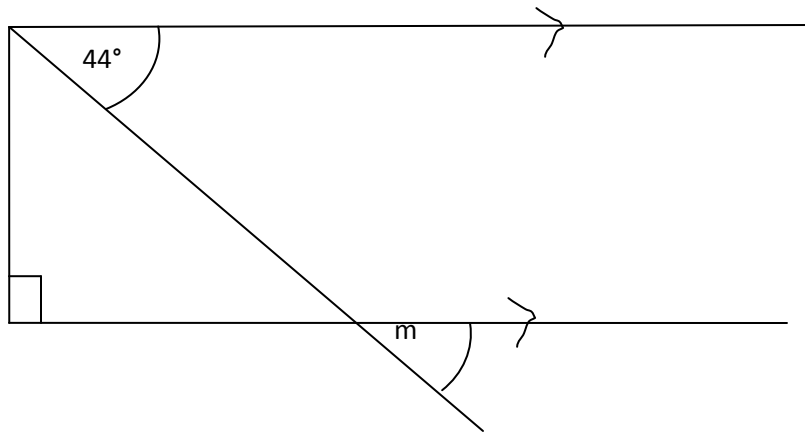

I)

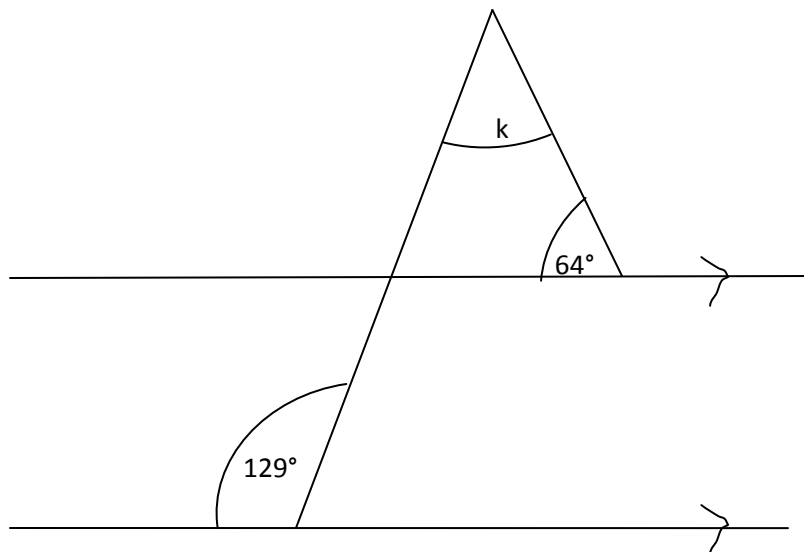

J)

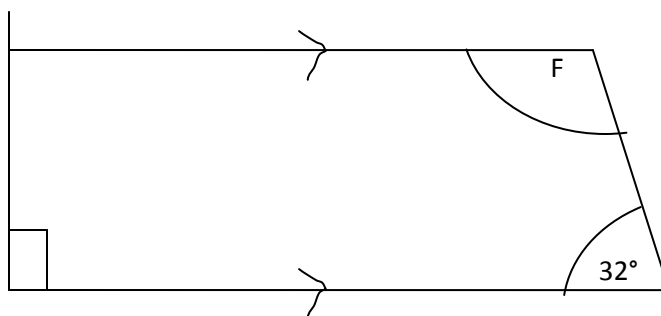

K)

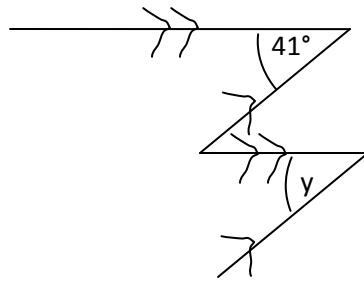

L)

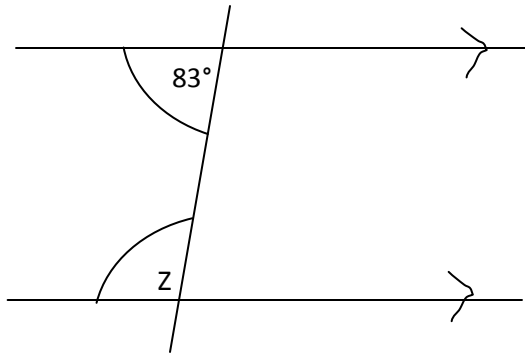

M)

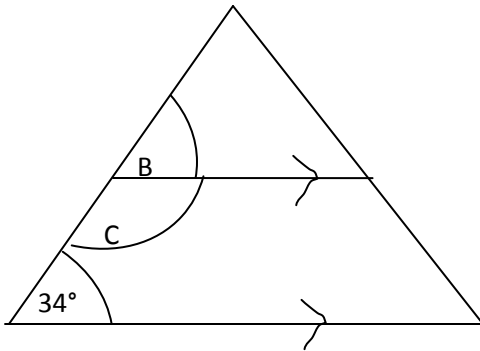

N)

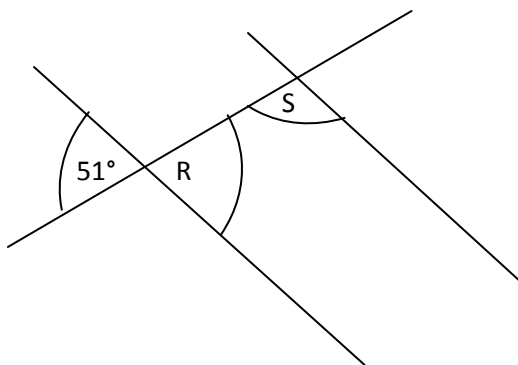

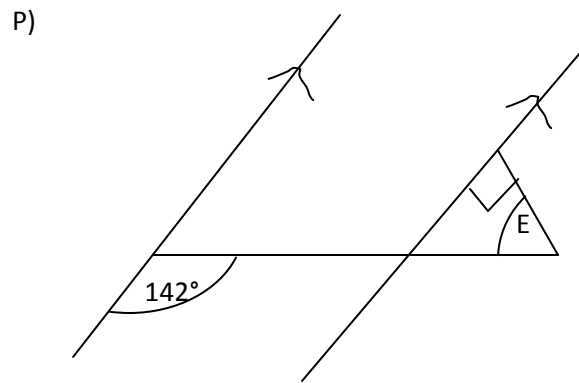
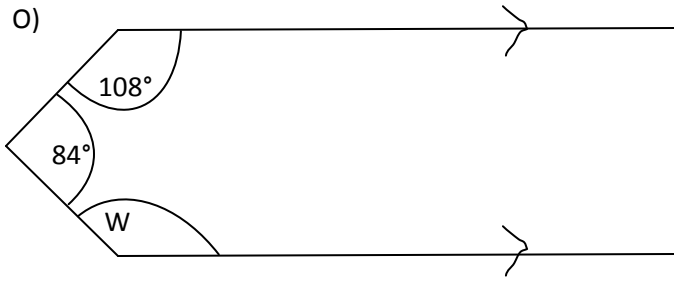

Q) The angle marked B is twice the angle marked C. Find angles B and C

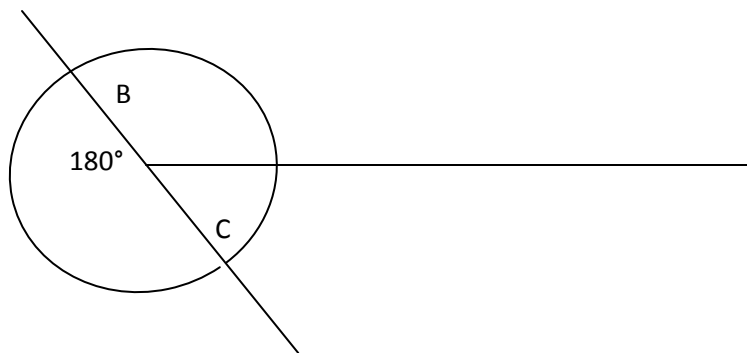

R) Angle R is thrice angle S. Form an equation and find R and S

